



In-Line duct fans SWF Range of direct drive centrifugal fans, manufactured from high grade pressed galvanized steel protected against corrosion by polyester paint finish. All the fans are provided with a removable top for easy access to motor for cleaning or inspection, a large grille opening, a back-draft damper, a pre-wired terminal box and a backward curved centrifugal impeller. All the motors are single-phase 230V-50Hz, IP44, Class B (models 100, 100X and 150) or Class F (models 150X and 200), with ball bearings greased for life, and safety thermal overload protection of manual reset type of 130°C. The SWF series is ideally suited for a wide range of residential, commercial and industrial exhaust ventilation applications.



Backward curved centrifugal impellers
To prevent accumulation of dirtiness. Dynamically balanced according to ISO 1940 standard.



Outdoor location
Outdoors installed
Specially designed to be installed outdoors.

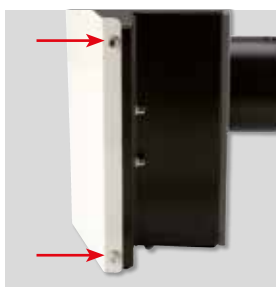

Removable cover
Easy access for cleaning or to check the impeller and motor.



Back draft shutter
To prevent air entry and limit heat leakage when the extractor is not operating. It opens due to the pressure of the air.



Discharge protection
Bird proof guard.

TECHNICAL CHARACTERISTICS

Before installation check that the product electrical characteristics listed on the data plate label (voltage, power, frequency, etc.) match those of the intended electrical supply.

Model	Speed (rpm)	Maximum absorbed power (W)	Maximum absorbed current (A)	Maximum airflow (m ³ /h)	Operating temperature (°C)	Sound pressure level* (dB(A))
SWF-100	2100	48	0,22	165	-40°C/+40°C	51
SWF-100X	2600	72	0,35	325	-40°C/+40°C	55
SWF-150	2540	80	0,34	485	-40°C/+40°C	58
SWF-150X	2700	130	0,53	625	-40°C/+60°C	59
SWF-200	2700	130	0,53	770	-40°C/+60°C	56

* Measured at 1 m at free field, with ducted inlet and outlet.

DIMENSIONS (mm)

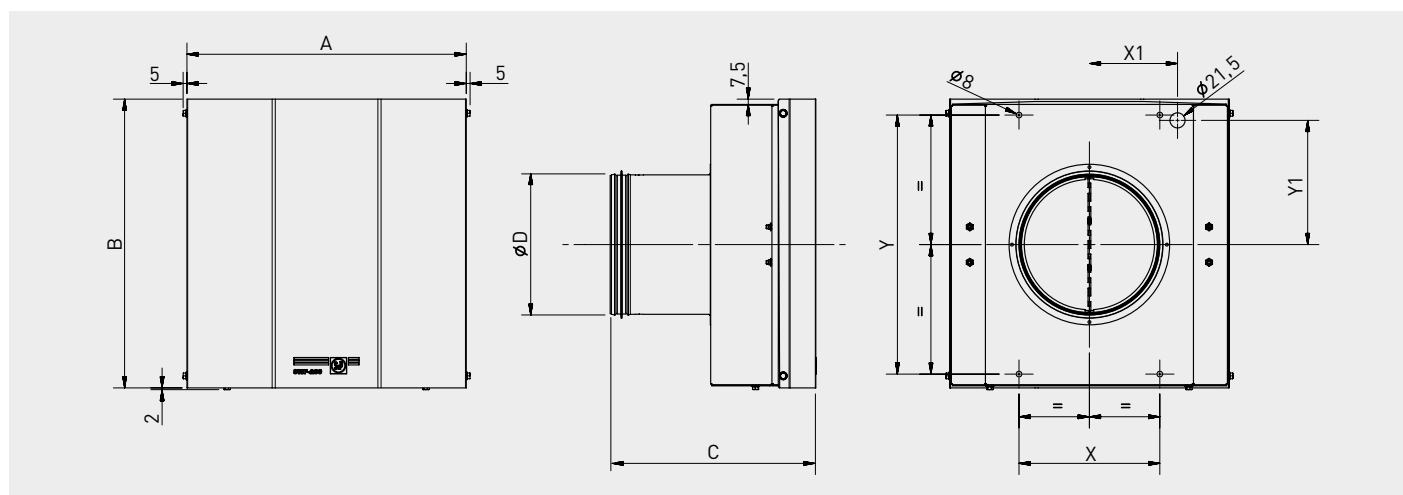

Model	A	B	C	D	X	X1	Y	Y1
SWF-100	337	337	228	100	150	100	295	140
SWF-100X	337	337	228	100	150	100	295	140
SWF-150	337	337	260	150	150	100	295	140
SWF-150X	395	408	254	150	199	125	366	180
SWF-200	395	408	291	200	199	125	366	180

ACOUSTIC CHARACTERISTICS

Sound power spectrum in dB(A), at the fan inlet and outlet, at 3 working points of the performance curve.

Model	63	125	250	500	1.000	2.000	4.000	8.000
100 Inlet	33	43	48	54	58	56	48	39
	36	43	53	57	61	58	50	41
	38	45	55	61	64	60	52	43
100 Outlet	34	45	58	60	60	59	56	46
	36	47	62	63	62	61	58	49
	39	48	64	66	65	63	60	51
150 Inlet	36	45	55	66	65	64	56	53
	33	42	55	66	62	63	55	45
	31	42	55	65	62	61	55	42
150 Outlet	37	47	58	67	67	67	63	56
	39	49	61	71	71	70	67	60
	41	51	62	72	73	72	70	61
200 Inlet	37	48	65	73	73	70	65	58
	36	49	63	70	69	66	59	50
	40	58	67	74	69	64	56	46
200 Outlet	37	48	60	72	71	71	68	60
	38	55	64	71	67	64	60	49
	38	55	64	71	67	64	60	49

PERFORMANCE CURVES

- q_v : Airflow in m^3/h and m^3/s .
- p_{sf} : Static pressure in mmWG and Pa.
- Dry air at 20°C and 760 mmHg.
- Performance data in accordance with ISO 5801 and AMCA 210-99 Standards.

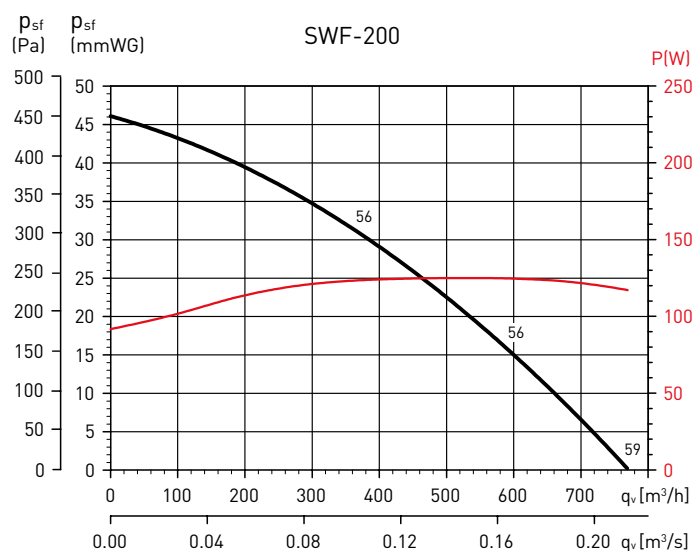
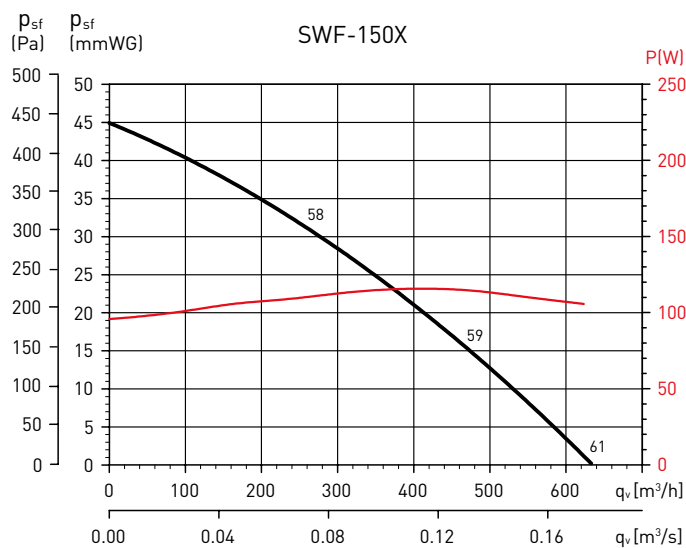
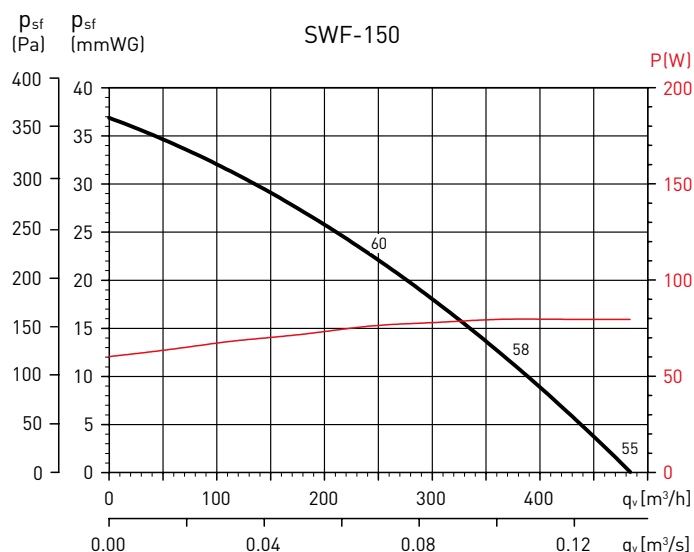
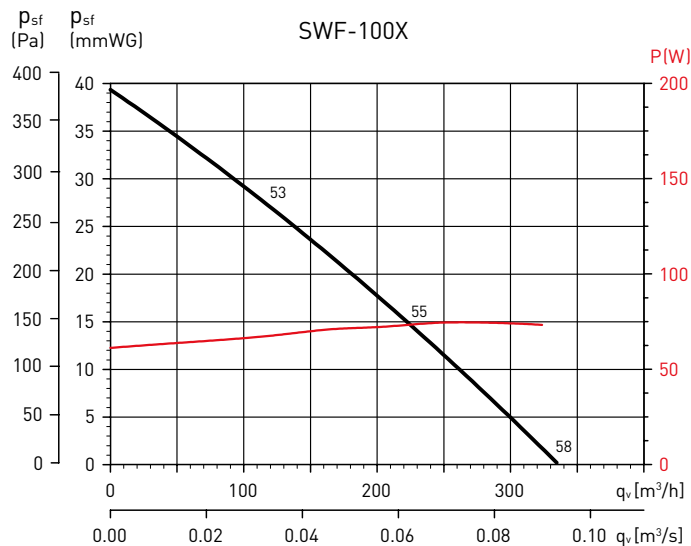
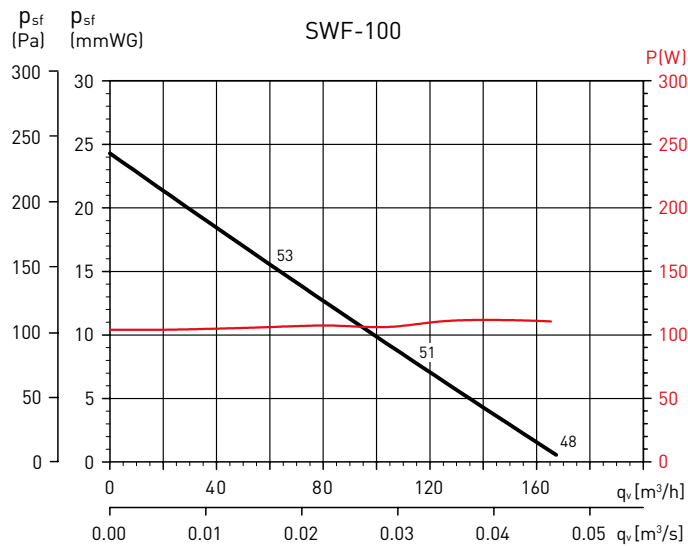

ACCESSORIES



REB
Electronic single
phase speed
controllers.



RMB
Single phase auto
transformer speed
controllers.



BOC
Metallic interior
air valves.



BOR
Plastic interior
air valves.